

Safety Controllers / Safety Relay Unit



SFC / SFC-R Series

For your safety, read and follow the considerations written in the instruction manual, other manuals and Autonics website.

The specifications, dimensions, etc. are subject to change without notice for product improvement. Some models may be discontinued without notice.

Major Features

- Slim size (17.5 / 22.5 / 35 mm) for saving installation space
- Various LED indicators for displaying status (power / input / logic input / error / feed back / output)
- Screw / Screwless connection models
- P channel FET / Relay contact safety output models
- Available off-delay output and time setting (advanced/non-contact door switch/relay output models)
- Available logic (AND) connection and extension relay unit connection (advanced/non-contact door switch models)
- The product structure conforms with international safety regulations and standards : SIL3, SIL CL3, PLe, CE, UL Listed, and S Mark

Safety Considerations

- Observe all 'Safety Considerations' for safe and proper operation to avoid hazards.
- ⚠ symbol indicates caution due to special circumstances in which hazards may occur.

⚠ Warning Failure to follow instructions may result in serious injury or death.

- 01. Fail-safe device must be installed when using the unit with machinery that may cause serious injury or substantial economic loss. (e.g. nuclear power control, medical equipment, ships, vehicles, railways, aircraft, combustion apparatus, safety equipment, crime/disaster prevention devices, etc.)**
Failure to follow this instruction may result in personal injury, economic loss or fire.
- 02. Responsible person for use is an operator who:**
- is fully knowledgeable about the installation, settings, use and maintenance of the product
- is familiar with the requirements of laws, regulations and standards in the country or region where the product is installed and used.
Responsible person for use has an obligation to educate the requirements to machine users.
Machine users are persons who have been fully trained by the responsible person for use and can operate the machine correctly. When any error occurs during the operation of the machine control system, they have a responsibility to report it to the responsible person for use immediately.
If an unqualified person operates the product, it may result in personal injury, economic loss or fire.
- 03. Qualified personnel shall carry out installation, configuration and combination with the machine control system.**
If an unqualified person carry out installation, configuration and combination with the machine control system, it may cause malfunction or result in accidents.
- 04. When the connected devices (e.g., motor) is not operating after installation, check that functions and settings of the product correctly operate as you intended.**
Failure to follow this instruction may result in personal injury, economic loss or fire.
- 05. Be sure to consider the delay of the safety output when determining the safety distance to the hazardous source due to the response time (safety input and logic input), setting of off-delay time and off-delay time accuracy.**
The machine may not stop before an operator reaches the hazardous zone so that it may result in personal injury and economic loss.
- 06. Do not use the unit in the place where flammable/explosive/corrosive gas, high humidity, direct sunlight, radiant heat, vibration, impact, salinity, moisture, or steam, or dust may be present.**
Failure to follow this instruction may result in explosion or fire.
- 07. Do not disassemble or modify the unit.**
Failure to follow this instruction may result in personal injury or fire. In addition, the manufacturer does not guarantee the performance and functionality.
- 08. Do not connect, repair, inspect, or replace the unit while connected to a power source.**
Failure to follow this instruction may cause the external devices connected to the product may unexpectedly operate. For more information, please refer to laws, regulations and standards in the country or region.
- 09. Install the product on a device panel or DIN rail inside the control room with IP54 or higher protection structure.**
Failure to follow this instruction may result in fire or electric shock.
- 10. When using the product mounted on a DIN rail, fix it using an End plate (sold separately).**
Failure to follow this instruction may result in fire or electric shock.
- 11. When you use the product in a place where vibrations or shocks are very high, use screws to fix it to the panel for use.**
Failure to follow this instruction may result in personal injury and fire.
- 12. Check 'Connections' before wiring. And make sure that there are no safety problems.**
Failure to follow this instruction may result in fire.
- 13. You must conduct daily and regular inspections every six months.**
Failure to follow this instruction may result in personal injury, economic loss or fire due to the malfunction of the product.
- 14. The auxiliary output is non-safety output, therefore, do not use it for safety purposes.**
Failure to follow this instruction may result in personal injury, economic loss or fire.
- 15. This product is designed to comply with industrial environment A. Use of this product in residential environment B may cause unwanted electromagnetic interference. In this case, it requires to take appropriate mitigation measures.**

⚠ Caution Failure to follow instructions may result in injury or product damage.

- 01. Use the product within the rated specifications.**
Failure to follow this instruction may result in fire or product damage.
- 02. Use a dry cloth to clean the unit, and do not use water or organic solvent.**
Failure to follow this instruction may result in fire.
- 03. When connecting the power input and relay output, use AWG 18 (0.8mm²) cable or over and tighten the terminal screw model with a tightening torque of 0.3 N·m. Use the copper-conductor wire with the temperature class 60°C.**
Failure to follow this instruction may result in fire or malfunction due to contact failure.
- 04. Keep the product away from metal chip, dust, and wire residue which might flow into the unit.**
Failure to follow this instruction may result in fire, product damage or malfunction.
- 05. The durability of relay output depends on conditions of relay switching and load. Be sure to test under actual operating conditions and use it within the appropriate switching cycles without problem on product performance.**
Failure to follow this instruction may result in fire or product damage.
- 06. Do not touch the relay output terminal immediately after the power source to the load is disconnected.**
Failure to follow this instruction may result in electric shock.

Cautions during Use

- Follow instructions in 'Cautions during Use'. Otherwise, it may cause unexpected accidents.
- The power input is insulated and limited voltage/current or use SELV, Class 2 power supply.
- Connect a protective device (fuse etc.) to the safety output terminal for short-circuit, overcurrent and ground fault protection.
Failure to follow this instruction may result in fire or malfunction.
- Do not use AC and DC circuits together between safety output terminals.
-SFC-R212: between 13-14 terminal and 23-24 terminal
-SFC-R412, SFC-ER412: between 13-14 terminal and 23-24 terminal or between 33-34 terminal and 43-44 terminal
-SFC-R212-R2□: between 13-14 terminal and 23-24 terminal or between 37-38 terminal and 47-48 terminal
- Keep away from high voltage lines or power lines to prevent inductive noise. In case installing power line and input signal line closely, use line filter or varistor at power line and shielded wire at input signal line. Do not use the product near the equipment which generates strong magnetic force or high frequency noise.
- Do not drop the product or expose it to excessive vibration or shock. It may cause failure or malfunction.
- Be sure to turn off the power before connecting, inspecting and repairing the product. It may cause malfunction or short circuit
- When mounting the products close to each other, the rated current of the relay output is 3A. Do not apply a current greater than 3A. If the current in the relay output flows 3A, or more, make sure that the distance between the products should be 20mm or more.
- Assessment of conformity to the required safety level is evaluated for the entire system. Please consult with a certified certification body regarding the assessment procedure.
- Be sure to set the off-delay time to maintain the safety function of the system. Set the setting of off-delay switch on both the front and back sides to the same value. If you set it differently, an error occurs.
- For switches used for safety inputs, logic input and feedback start input, use a switch with contacts capable of normally switching the micro loads (24VDC=, 5mA).
- It should be done away regarded as an industrial waste. For more information, please refer to laws, regulations and standards in the country or region.
- This unit may be used in the following environments.
- Indoors (in the environment condition rated in 'Specifications')
- Altitude max. 2,000m
- Pollution degree 3
- Installation category III

Ordering Information

This is only for reference.
For selecting the specific model, follow the Autonics web site.

SFC	-	①	②	③	②	-	④	⑤	⑥	-	⑦
-----	---	---	---	---	---	---	---	---	---	---	---

- | | |
|---|--|
| ① Function
No mark: Basic unit
A: Advanced unit
N: Non-contact door switch unit
(for Autonics SFN Series)
ER: Expansion relay unit
R: Relay unit | ⑤ No. of Off-delay outputs
No mark: None
2: 2 |
| ② No. of safety instantaneous outputs
Number: Number of outputs | ⑥ Max. Off-delay time
Number: Time (unit: sec) |
| ③ No. of auxiliary outputs
Number: Number of outputs | ⑦ Terminal type
No mark: Screw
L: Screwless |
| ④ Off-delay output elements
No mark: P channel FET
R: Relay (Relay unit) | |

Specifications

Unit	Basic	Advanced	Non-contact door switch
Model	SFC-422-□	SFC-A322-2□-□	SFC-N322-2□-□
Power supply	24 VDC=		
Allowable voltage range	85 to 110% of rated voltage		
Power consumption ⁽⁰¹⁾	≤ 2.5 W	≤ 3.0 W	≤ 3.5 W
Input	ON: ≥ 11 VDC= ≥ 5 mA, OFF: ≤ 5 VDC= ≤ 1 mA		
Input time	≥ 50 ms, feedback start (manual): ≥ 100 ms		
Cable	≤ 100 m (≤ 100Ω, ≤ 10nF)		
Safety output	P channel FET ⁽⁰²⁾		
Instantaneous	4 ×	3 × ⁽⁰³⁾	3 × ⁽⁰³⁾
Off-delay ⁽⁰⁴⁾	-	2 × ⁽⁰⁵⁾	2 × ⁽⁰⁵⁾
Time accuracy	-	≤ ± 5%	≤ ± 5%
Load current	Below 2-point output: ≤ DC 1 A, Over 3-point output: ≤ DC 0.8 A		
Leakage current	≤ 0.1 mA		
Operating time (OFF → ON) ⁽⁰⁵⁾	Safety input: ≤ 50 ms		Logic input: ≤ 200 ms
Response (return) time (ON → OFF) ⁽⁰⁵⁾	≤ 15 ms, non-contact door switch input or logic input: ≤ 20 ms		
Auxiliary output	2 × PNP transistor: X1, X2 (error)		
Load current	≤ 100 mA		
Leakage current	≤ 0.1 mA		
Logical AND connections	No. of connections: max. 4 units, no. of total connections: max. 20 units No. of layers: max. 5 layers, cable length: ≤ 100 m		
SFN connections ⁽⁰⁶⁾	-	-	Max. 30 units
Approval	IEC/EN 61508 (SIL3), IEC/EN 62061 (SILCL3) IEC/EN 60947-5-1, EN ISO 13849-1 (Category 4, PLe) UL listed E249635		
Certification	CE ⁽⁰¹⁾ ⁽⁰²⁾ ⁽⁰³⁾ ⁽⁰⁴⁾ ⁽⁰⁵⁾		
Unit weight (package)	≈ 70 g (≈ 120 g)	≈ 90 g (≈ 140 g)	≈ 100 g (≈ 150 g)

- Not include the power consumption of loads.
(SFC-N exclude the power supplied to the non-contact door switch.)
- Includes a diagnostic pulse (max. 600 μs). Be cautious when using the output signal as an input signal for the control device.
- Available changing via setting switch on the back side of the product.
- Available to set Off-delay time (max. 3 sec. / 300 sec., depends on model)
- The operation (response) time of each model. The time increases when a logical connection or expansion relay unit is connected.
- SFC-N units can only be connected to Autonics non-contact door switch units SFN Series.

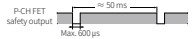

Unit	Expansion relay	Relay		
Model	SFC-ER412-□	SFC-R412-□	SFC-R212-□	SFC-R212-R2□-□
Power supply	24 VDC=			
Allowable voltage range	85 to 110% of rated voltage			
Power consumption ⁽⁰¹⁾	≤ 2.5 W	≤ 4.0 W	≤ 4.0 W	≤ 6.0 W
Input	ON: ≥ 11 VDC= ≥ 5 mA, OFF: ≤ 5 VDC= ≤ 1 mA			
Input time	≥ 50 ms, feedback start (manual): ≥ 100 ms			
Cable	≤ 100 m (≤ 100Ω, ≤ 10nF)			
Safety output	Relay (A contact) Relay (A contact)			
Instantaneous	4 ×	4 ×	2 ×	2 ×
Off-delay ⁽⁰²⁾	-	-	-	2 ×
Time accuracy	-	-	-	≤ ± 5%
Capacity	240 VAC~ 5 A resistance load, 30 VDC= 5 A resistance load			
Life expectancy	Mechanical: ≥ 10,000,000 operations, Malfunction: ≥ 50,000 operations			
Contact resistance	≤ 100 mΩ			
Inductive load switching	IEC60947-5-1: AC-15(230 V/2 A), DC-13(24 V/1.5 A), UL508: B300/R300			
Conditional short-circuit current	100 A ⁽⁰³⁾			
Operating time (OFF → ON) ⁽⁰⁴⁾	≤ 30 ms ⁽⁰⁵⁾	≤ 100 ms		
Response (return) time (ON → OFF) ⁽⁰⁴⁾	≤ 10 ms	≤ 15 ms		
Auxiliary output	1 × PNP transistor: X2 (error)	1 × PNP transistor: X1		
Load current	≤ 100 mA	≤ 100 mA		
Leakage current	≤ 0.1 mA			
Expansion units connections	Max. 5 units	-		
Approval	IEC/EN 61508 (SIL3), IEC/EN 62061 (SILCL3) IEC/EN 60947-5-1, EN ISO 13849-1 (Category 4, PLe) UL listed E249635			
Certification	CE ⁽⁰¹⁾ ⁽⁰²⁾ ⁽⁰³⁾ ⁽⁰⁴⁾ ⁽⁰⁵⁾			
Unit weight (package)	≈ 100 g (≈ 150 g)	≈ 110 g (≈ 160 g)	≈ 80 g (≈ 130 g)	≈ 110 g (≈ 150 g)

- Not include the power consumption of loads.
- Available to set Off-delay time (max. 3 sec. / 30 sec., depends on model)
- Use 6 A fast-blow fuse under the IEC 60127 standard as a short-circuit protection device.
- The operation (response) time of each model. The time increases when a logical connection or expansion relay unit is connected.
- Except operation time of advanced unit, non-contact door switch unit

Pollution	3
Overvoltage category	III
Impulse withstand voltage for relay unit (IEC/EN 60947-5-1)	Input terminals and relay output terminals: 6 kV Relay contacts between 13-14 / 23-24 and 33-34 / 43-44 (37-38 / 47-48): 6 kV between 13-14 and 23-24: 4 kV between 33-34 and 43-44 (37-38 and 47-48): 4 kV
Dielectric strength	Basic / Advanced / Non-contact door switch unit: 500 VAC~ 50/60 Hz for 1 min. (between all terminals and case) Expansion relay / relay unit: 1,500 VAC~ 50/60 Hz for 1 min. (between all terminals and case) 2,500 VAC~ 50/60 Hz for 1 min. (between input terminals and output terminals ⁽⁰¹⁾)
Insulation resistance	≥ 100 MΩ (500 VDC= megger)
Vibration ⁽⁰²⁾	0.75 mm amplitude at frequency of 10 to 55 Hz (for 1 min) in each X, Y, Z direction for 1 hour
Vibration (malfunc.) ⁽⁰²⁾	0.5 mm amplitude at frequency of 10 to 55 Hz (for 1 min) in each X, Y, Z direction for 10 minutes
Shock ⁽⁰²⁾	300 m/s ² (≈ 30 G) in each X, Y, Z direction for 3 times
Shock (malfunc.) ⁽⁰²⁾	100 m/s ² (≈ 10 G) in each X, Y, Z direction for 3 times
Protection structure	IP20
Ambient temperature	-10 to 55 °C, storage: -25 to 65 °C (rated at no freezing or condensation)
Ambient humidity	25 to 85 %RH, storage: 25 to 85 %RH (rated at no freezing or condensation)

- In case of relay unit, output terminals between 13-14, 23-24 and 33-34, 43-44 (37-38, 47-48)
- This data based on the product is mounted with bolts. When installing DIN rail, use the product in an environment with small vibration (condition: less than 0.4 mm double amplitude)

Parts Descriptions

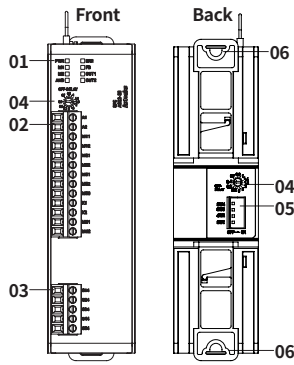

- 01. Indicators
- 02. Power supply, I/O signal terminals
- 03. Safety output (P ch FET or relay) terminals
- 04. Setting switch for off-delay time
(only off-delay output model)
The settings of the switch on the front and back of the product must be the same. Other settings are displayed as an error.
- 05. Setting switch for function
(only advanced / non-contact door switch unit)
The setting of switches for each function must meet each other. Other settings are displayed as an error.

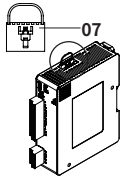

07
08
Expansion relay unit

- 06. Rail Lock
- 07. Loop connector
(only advanced / non-contact door switch unit)
Do not disconnect the loop connector when using a single unit. When connecting the expansion relay unit, insert the loop connector to the loop port of a unit, which located at the end position (farthest to the right). If the loop connector is not inserted, FB error occurs.
- 08. Expansion connector
When connecting the expansion relay unit, remove the loop connector on the top of the controller and insert the expansion connector.

Indicators

Indicators	Model	SFC	SFC-A	SFC-N	SFC-ER	SFC-R□12-□	SFC-R212-R2□-□
PWR (green)	Power	●	●	●	●	●	●
M1 (white)	Safety input 1	●	●	●	—	●	●
M2 (white)	Safety input 2	●	●	●	—	●	●
NS (white)	Non-contact door switch input	—	—	●	—	—	—
AND (white)	Logic input	—	●	●	—	—	—
ERR (red)	Error	●	●	●	●	●	●
FB (white)	Feedback start input	●	●	●	—	●	●
OUT1 (green)	Instantaneous safety output	●	●	●	●	●	●
OUT2 (green)	Off-delay safety output	—	●	●	—	—	●

Setting Switches

Setting Switch for off-delay time

- Only off-delay output model
- Available to set off-delay time (max. 3 / 300 / 30 sec., depends on model)
- The settings of the switch on the front and back of the product must be the same. Other settings are displayed as an error.
- If the off-delay time is set as 0 (factory default), the product operates as the instantaneous output.

Model	Max. 3 sec.	Max. 300 sec.	Max. 30 sec.
SFC-A322-23-□ SFC-N322-23-□ SFC-R212-R23-□	0/0.2/0.3/0.4/0.5/0.6/0.7/0.8/0.9/1.0/1.2/1.4/1.8/2.0/2.5/3.0 sec.	0/10/20/30/40/50/60/70/80/90/100/120/150/180/240/300 sec.	0/1/2/4/5/6/7/8/9/10/12/14/16/20/25/30 sec.

Setting switch for function

- Only advanced / Non-contact door switch unit.
- The setting of switches for each function must meet each other. Other settings are displayed as an error

Function	SW1	SW2	Logic (AND) input
Logic (AND) input	OFF	OFF	Not available
	ON	ON	Available

Function	SW3	SW4	Instantaneous safety output	Off-delay safety output
Off-delay safety output points	OFF	OFF	S14, S24, S34	S44, S54
	ON	ON	S14	S24, S34, S44, S54

Dimensions

- Unit: mm, For the detailed drawings, follow the Autonics web site.
- The below is based on SFC-A (screw type) model

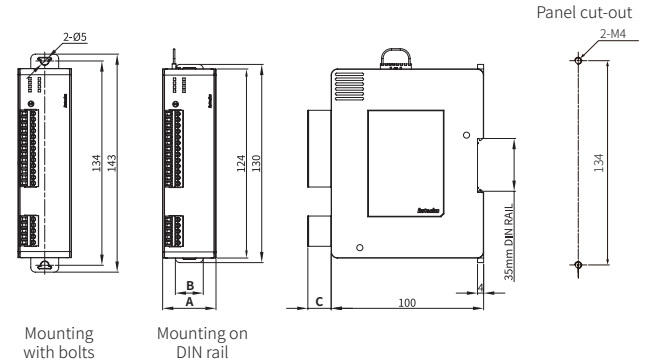

Model		A	B	C
Basic unit	SFC-422-□	22.5	18.3	Screw type: 15.3 Screwless type: 15.5
Advanced unit	SFC-A322-□-□	35	18.3	
Non-contact door switch unit	SFC-N322-□-□	35	18.3	
Expansion relay unit	SFC-ER412-□	22.5	18.3	
	SFC-R412-□	22.5	18.3	
Relay unit	SFC-R212-□	17.5	13.3	
	SFC-R212-R□-□	22.5	18.3	

Installation

Mounting with bolts

1. Pull each rail locks to up and down.
(attach/detach: ≥ 25N)
2. Insert bolts and fix it on rail lock.
(fixing torque: 1.0 N m to 1.5 N m)

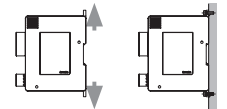

Mounting on DIN Rail

1. Hang the top rail lock to DIN rail.
2. Push and press the module to down direction.
3. Install END PLATE at both ends of the module to fix the products.
(It is the same way when using one unit.)

Removing on DIN Rail

1. Insert a screwdriver into the rail hook of the lower rail lock.
2. Lift the screwdriver and pull the lower rail lock downward.
3. Lift the module with the lower rail lock pulled down.

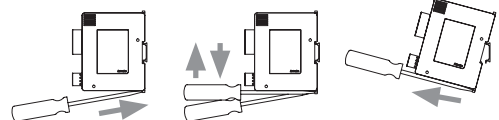

How to connect the expansion relay units (SFC-ER412-□)

In case of advanced unit and non-contact door switch unit, it is possible to increase the number of safety outputs of relay type by connecting expansion relay unit (SFC-ER412-□). (Up to 5 expansion relay units can be connected to each controller)

When the safety output of the controller is on, the output of the expansion relay unit also goes to on.

The controller is installed from the end of the left or right side.

Power of expansion relay unit should be supplied individually.

E.g.) Installation from the end of left side

1. Install the expansion relay units (max. 5 units) toward the right side based on the controller.
2. Remove the loop connector on the top of the controller.
3. Connect the expansion connector of each right (expansion relay unit) to the expansion connector of the left unit.
4. Insert the loop connector removed in 2 into the loop port of the unit, which located at the end position (farthest to the right).

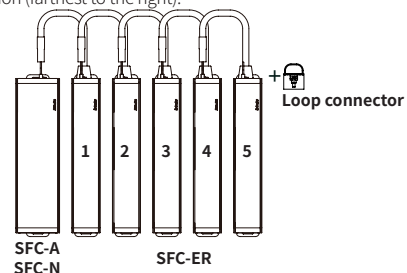

Connections

Basic unit: SFC-422-□

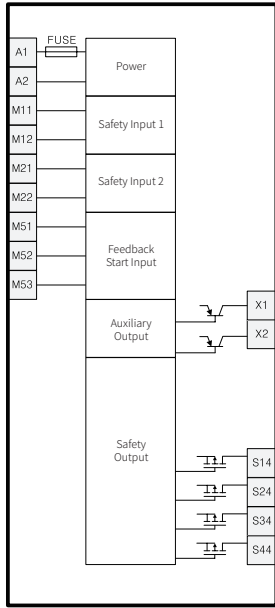

Advanced unit: SFC-A322-23□-□

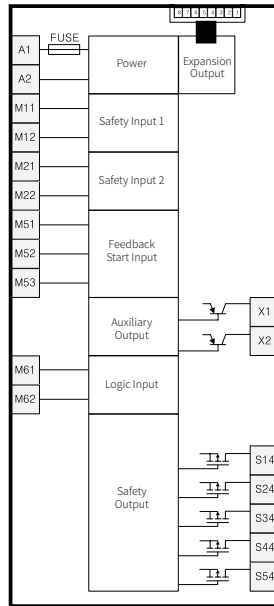

Non-contact door switch unit: SFC-N322-23□-□

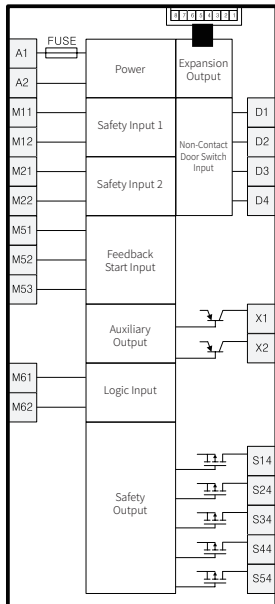

Expansion relay unit: SFC-ER412-□

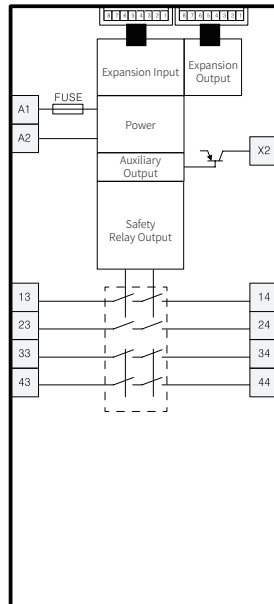

Relay unit: SFC-R□12-□

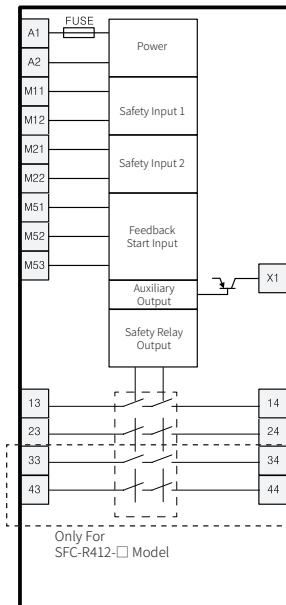

Relay unit: SFC-R212-R2□-□

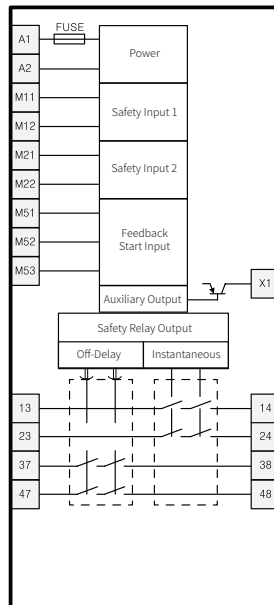

Wiring of Input

A1, A2: Power supply input

The input terminals for power supply. Connect the positive side (24 VDC≐) of the external power supply to the A1 terminal and connect the negative side (GND) of the external power supply to the A2 terminal.

M11, M12: Safety input 1, M21, M22: Safety input 2

To turn ON the safety outputs, ON state signals must be input to both safety input 1 and safety input 2.

1-channel safety input

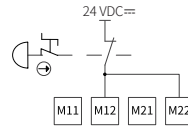

2-channel safety input

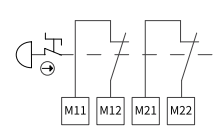
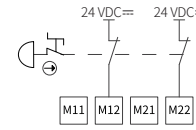

M51, M52, M53: Feedback start input

Auto start

To turn ON the safety outputs, the feedback loop must remain ON state.

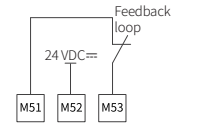

Manual start

To turn ON the safety outputs, the feedback loop must remain ON state and the signal input to M52 must be changed from OFF state to ON state, and then to OFF state.

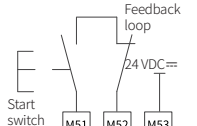

(The duration that the start switch is in the ON state: min. 100 ms)

M61, M62: Logic input

Connect the safety outputs of the upper unit to the logic (AND) input of the lower unit. To use the logic input function, SW1 and SW2 of switch for setting function must be set to ON state.

Up to four units (advanced / non-contact door switch unit) can be connected as logic (AND) connections in parallel per safety output.

Up to four units can be connected in serial logic (AND) connection.

Up to 20 units can be connected to the entire unit via logic connection.

Basic unit can only be used in layer 1.

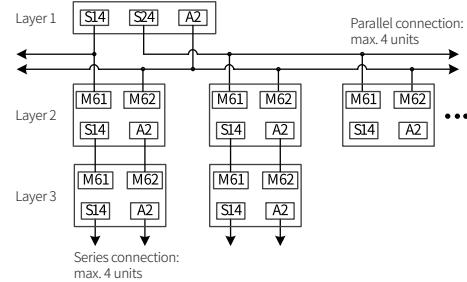

Logical AND Connections

Unit	Basic / Advanced / Non-contact door switch unit
No. of units connected to logical AND connections	Max. 4 units
Total no. of units connected to logical AND connections	Max. 20 units
No. of layers for logical AND connections	Max. 5 layers
Cable length for logical AND connections	Max. 100 m

Response time and Operating time

Layer	Item	Configuration	Max. response time (ON → OFF)		Max. operating time (OFF → ON)	
			Excepts	Includes	Excepts	Includes
Layer 1	Expansion unit	Basic / Advanced / Non-contact door switch unit	15 ms	25 ms	50 ms	80 ms
			30 ms	40 ms	250 ms	280 ms
Layer 2	Advanced / Non-contact door switch unit	Advanced / Non-contact door switch unit	45 ms	55 ms	450 ms	480 ms
			60 ms	70 ms	650 ms	680 ms
Layer 3	Advanced / Non-contact door switch unit	Advanced / Non-contact door switch unit	75 ms	85 ms	850 ms	880 ms
			75 ms	85 ms	850 ms	880 ms

D1, D2, D3, D4: Non-contact door switch input

All the non-contact door switch inputs connected to the non-contact door switch SFN Series must be ON as a required condition for the safety outputs to be ON. Up to 30 non-contact door switches can be connected.

For more information, refer to the non-contact door switch SFN Series instruction manual.

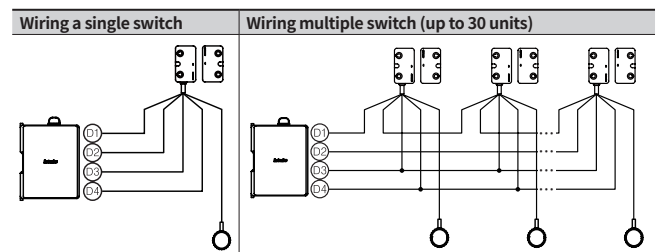

Wiring of Output

■ S14, S24, S34, S44, S54 : P channel safety outputs

The instantaneous or off-delay safety outputs go to ON or OFF based on the safety inputs, feedback start input, logic input, and input signals of non-contact door switch.

- Leave unused safety outputs in the OPEN state.
- Configure a protection circuit against the counter electromotive force when connecting inductive loads.
- To expand the number of safety outputs in the form of contacts, connect the expansion cable of the expansion relay unit to advanced unit or the expansion connector of non-contact door switch unit, and connect the loop connector to the expansion relay unit located at the end of position.
- Operation of safety output and safety off-delay output based on the safety input signal

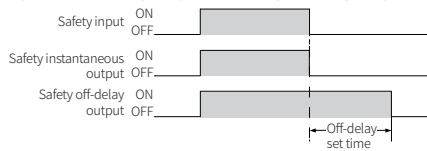

■ 13/14, 23/24, 33/34 (37/38), 43/44 (47/48) : Safety outputs of relay unit

The instantaneous or off-delay safety outputs go to ON or OFF based on the safety inputs, feedback start input.

- Leave unused safety outputs in the OPEN state.

■ X1: Auxiliary output 1

When the instantaneous safety outputs are ON, the X1 auxiliary output goes to ON.

When the instantaneous safety outputs are OFF, the X1 also goes to OFF.

- Leave unused auxiliary output in the OPEN state.

■ X2: Auxiliary output 2

X2 auxiliary output goes to ON when the ERR indicator turns on or flashes.

- Leave unused auxiliary output in the OPEN state.

Error Indication

When an error occurs, the ERR indicator and other indicators turn on or flash to notice the cause of error.

Be sure to check and take measures according to the table below, and turn the power on again. If the measures are not valid, please contact the Autonics.

Indicator	Others	Cause	Check and measures
ERR	PWR flashes	The power voltage is out of the allowable range.	Check the supplied power voltage.
	M1 flashes	Wiring error of safety input 1	Check the wiring to M11, M12 terminal.
		Failure of internal circuit of safety input 1	Please contact the Autonics.
	M2 flashes	Wiring error of safety input 2	Check the wiring to M21, M22 terminal.
		Failure of internal circuit of safety input 2	Please contact the Autonics.
	FB flashes	Wiring error of feedback start input	Check the wiring to M51, M52 and M53 terminal.
		Internal circuit error of feedback start input	Please contact the Autonics.
		Error at the power of expansion relay unit	Check the supplied power voltage to the expansion relay unit.
		Feedback error of the relay unit	Check the cable of expansion relay unit and loop connector connection.
		Safety output error of the relay unit	Please contact the Autonics.
	NS flashes	Wiring error of input and output of the non-contact door switch	Check the wiring to the D1 and D2 terminal of non-contact door switch.
		Wiring error of series connection of the non-contact door switch	Check the wiring to between the non-contact door switches.
		Failure of internal circuit of the non-contact door switch	Replace the non-contact door switch (SFN series).
	AND flashes	Wiring error of logic input	Check the wiring to M61 and M62 terminal.
		Setting error of logic input	Check the setting values of SW1 and SW2 at switch for logic (AND) input.
		Failure of internal circuit of logic input	Please contact the Autonics.
	OUT1 flashes	Wiring error of instantaneous safety output	Check the wiring to instantaneous safety output terminal.
		Failure of internal circuit instantaneous safety output	Please contact the Autonics.
	OUT2 flashes	Wiring error of the off-delay safety output	Check the wiring to the off-delay safety output terminal.
		Failure of internal circuit of the off-delay safety output	Please contact the Autonics.
Setting error of the off-delay time		Check the setting value of the switch for off-delay time.	
Flash	-	Error at internal circuit and output relay of the expansion relay unit	Please contact the Autonics.
OFF	M1 M2 flashes	The different input signal between safety input 1 and safety input 2	Check the wiring to the safety input devices. Check the input sequence of safety inputs.

Check and Maintenance

■ Check installation conditions

	Checklist	Check
1	The distance from hazardous zone or source of the machine to the product, safety sensors connected to the product, installed location is equal to or greater than calculated safety distance. Safety distance: ()mm / Actual distance: ()mm	
2	Installed in the environment without the material causing deformation such as corrosion or ignition.	
3	When installing the DIN rail or panel, the product is firmly fixed to prevent separation.	
4	There is no product damage or appearance problem.	

■ Check wiring connection

	Checklist	Check
1	The power supply used for devices related to the product and safety-related functions is 24VDC, and a dedicated power supply meets the specified rated specifications and is not connected to other devices or equipment.	
2	When connecting power supply, the polarity is not connected in reverse.	
3	The appearance of the wiring connected to the product is not damaged, such as cracking, breakage, etc. of the outer shell, and there is no cause for damage around the wiring.	
4	In case of connecting more than two products, it is configured for the dedicated series connection or mutual interference.	
5	The wiring connected to the product is correctly connected to each purpose.	
6	The wiring connected to the product is firmly fixed to prevent separation during use.	
7	In case of auxiliary output (AUX1,AUX2), it is configured to prevent the connection to safety-related part of the control system.	

■ Safety system-check in operation

	Checklist	Check
1	Inspect without operator in hazardous zone or near the source of hazard.	
2	The safety input signal is off while the machine is operating, then the safety system immediately stops.	
3	In case of the power shut down, the safety system stops and maintains the status.	
4	The actual machine response time (the time taken for the hazard source to stop) is less than the calculated time Calculated machine response time: ()ms / Actual machine response time: ()ms	

■ Daily inspection

	Checklist	Check
1	Accessible to hazardous zone or source of the machine only by passing through the detection zone of the product.	
2	The distance from hazardous zone or source of the machine to the product, safety sensors connected to the product, installed location is equal to or greater than calculated safety distance. Safety distance: ()mm / Actual distance: ()mm	
3	When installing the DIN rail or panel, the product is firmly fixed to prevent separation.	
4	The wiring connected to the product is firmly fixed to prevent separation during use.	
5	The appearance of the wiring connected to the product is not damaged, such as cracking, breakage, etc. of the outer shell, and there is no cause for damage around the wiring.	
6	The input/output wiring of the product is firmly fixed to prevent separation from each device.	
7	There is no product damage or appearance problem.	

■ Regular inspection

	Checklist	Check
1	The distance from hazardous zone or source of the machine to the product, safety sensors connected to the product, installed location is equal to or greater than calculated safety distance. Safety distance: ()mm / Actual distance: ()mm	
2	When installing the DIN rail or panel, the product is firmly fixed to prevent separation.	
3	The wiring connected to the product is firmly fixed to prevent separation during use.	
4	The appearance of the wiring connected to the product is not damaged, such as cracking, breakage, etc. of the outer shell, and there is no cause for damage around the wiring.	
5	The input/output wiring of the product is firmly fixed to prevent separation from each device.	
6	There is no product damage or appearance problem.	

Failure Rate

Type	Model	SIL	PFHD	PL	Category	MTTFd	DCavg	Note
SFC	SFC-422	SIL 3	3.39E-09	e	4	264.38 year	99.00%	
	SFC-422-L							
SFC-A	SFC-A322-23	SIL 3	5.29E-09	e	4	218.18 year	99.00%	
	SFC-A322-23-L				4		99.00%	
	SFC-A322-2300						99.00%	
	SFC-A322-2300-L						99.00%	
SFC-N	SFC-N322-23	SIL 3	7.36E-09	e	4	183.67 year	99.00%	
	SFC-N322-23-L				4		99.00%	
	SFC-N322-2300						99.00%	
	SFC-N322-2300-L						99.00%	
SFC-R	SFC-R212	SIL 3	5.29E-09	e	4	247.78 year	99.00%	
	SFC-R212-L				4		99.00%	
	SFC-R412						99.00%	
	SFC-R412-L						99.00%	
	SFC-R212-R23						99.00%	
	SFC-R212-R23-L						99.00%	
	SFC-R212-R230						99.00%	
SFC-R212-R230-L	99.00%							

Connection Examples 1

Advanced unit-Safety light curtain

Connections	Start	PL/Safety category
Safety controller: Advanced unit SFC-A Series Safety light curtain: SFL / SFLA Series Contactor of rated load (from Annex C of ISO 13849-1)	Auto	PLe/Cat.4 equivalent

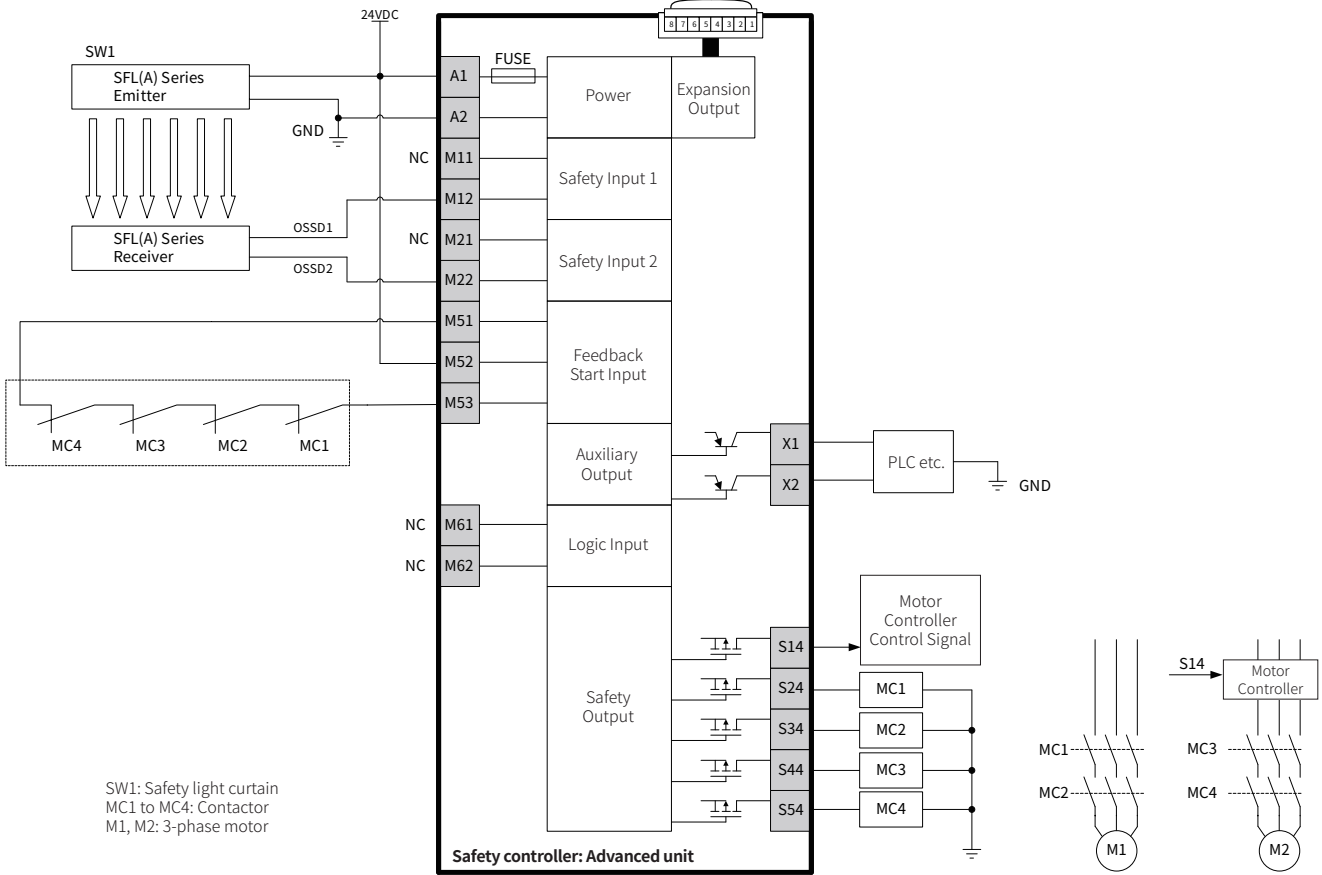

• Operation timing chart

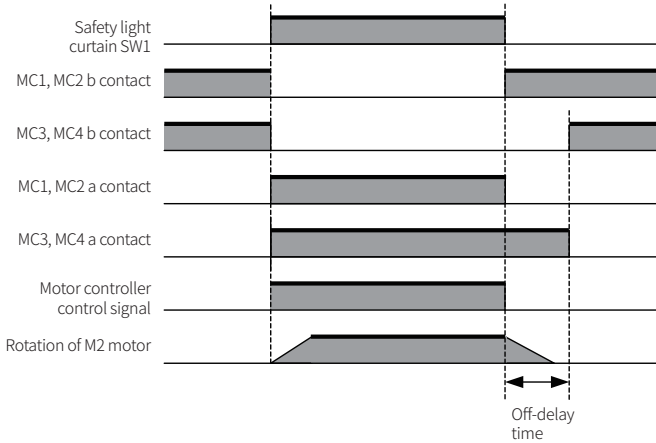

- For more information on wiring and detailed settings for safety light curtain (SFL/SFLA Series), see the "SFL/SFLA user manual."
- The control output of the safety light curtain (SFL(A) series) is based on the PNP output.
- When you do not use the logic input (M61, M62), set the switch of the logic (AND) input (SW1, SW2) to OFF.
- Set the switches for off-delay time on the front and back of the advanced unit to the same.

Connection Examples 2

Advanced unit-Safety door lock switch, Expansion relay unit

Connections	Start	PL/Safety category
Safety controller: Advanced unit SFC-A Series Safety door lock switch: SFDL Series Safety limit switch (from Annex C of ISO 13849-1) Safety emergency stop button switch: SF2ER Series Push button switch (from Annex C of ISO 13849-1) Contactor of rated load (from Annex C of ISO 13849-1)	Manual	PLe/Cat.4 equivalent
Safety controller: Expansion relay unit SFC-ER Series Contactor of rated load (from Annex C of ISO 13849-1)	-	

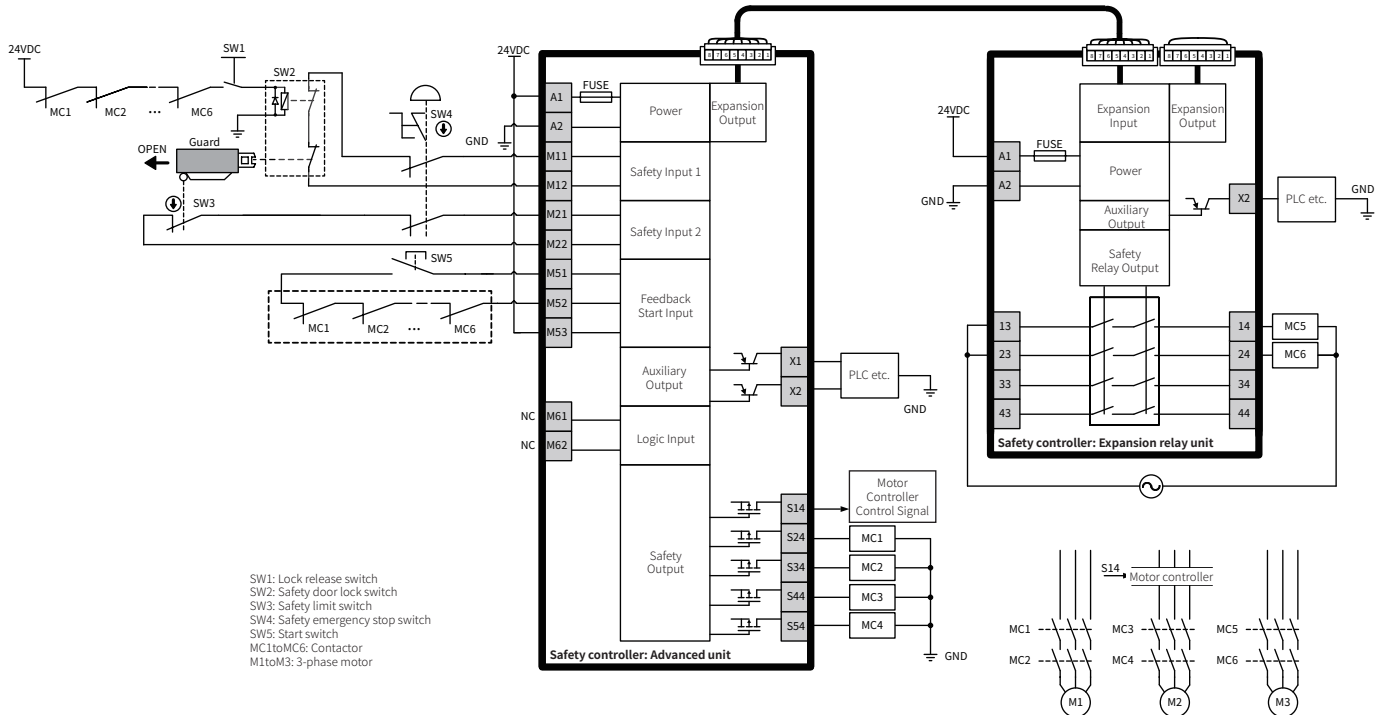

• Operation timing chart

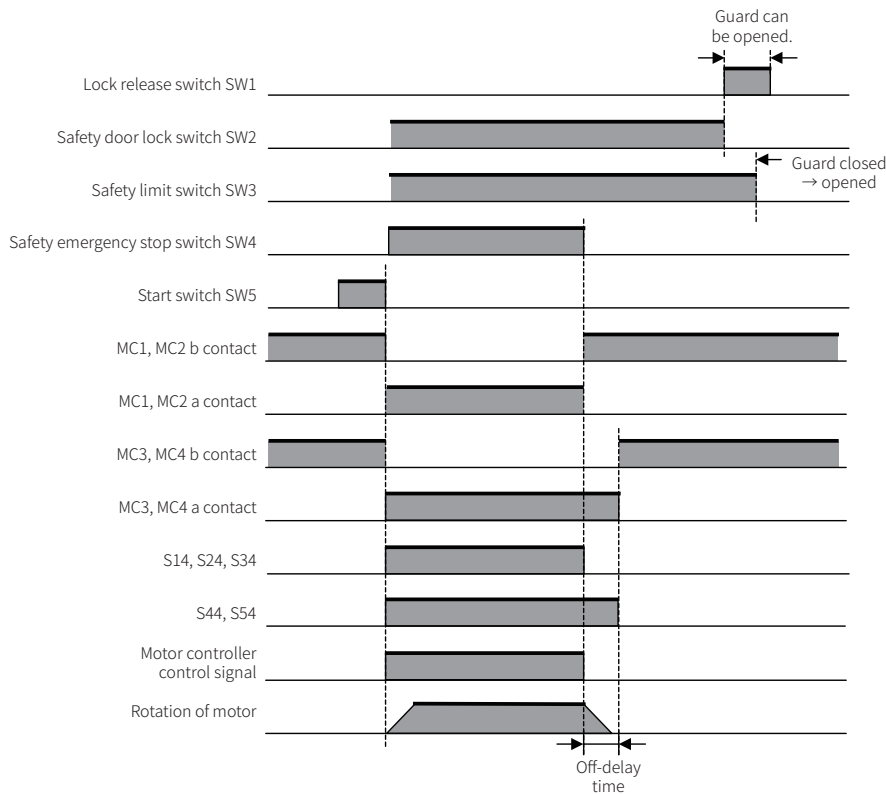

- When you do not use the logic input (M61, M62), set the switch of the logic (AND) input (SW1, SW2) to OFF.
- Set the switches for off-delay time on the front and back of the advanced unit to the same.
- Be sure to supply suitable DC or AC to the MC5 and MC6.

Connection Examples 3

■ Non-contact door switch unit-Safety non-contact door switch

Connections	Start	PL/Safety category
Safety controller: Non-contact door switch unit SFC-N Series Safety emergency stop button switch: SF2ER Series Safety limit switch (from Annex C of ISO 13849-1) Push button switch (from Annex C of ISO 13849-1) Safety non-contact door switch: SFN Series Contactor of rated load (from Annex C of ISO 13849-1)	Auto	PLd/Cat.3 equivalent

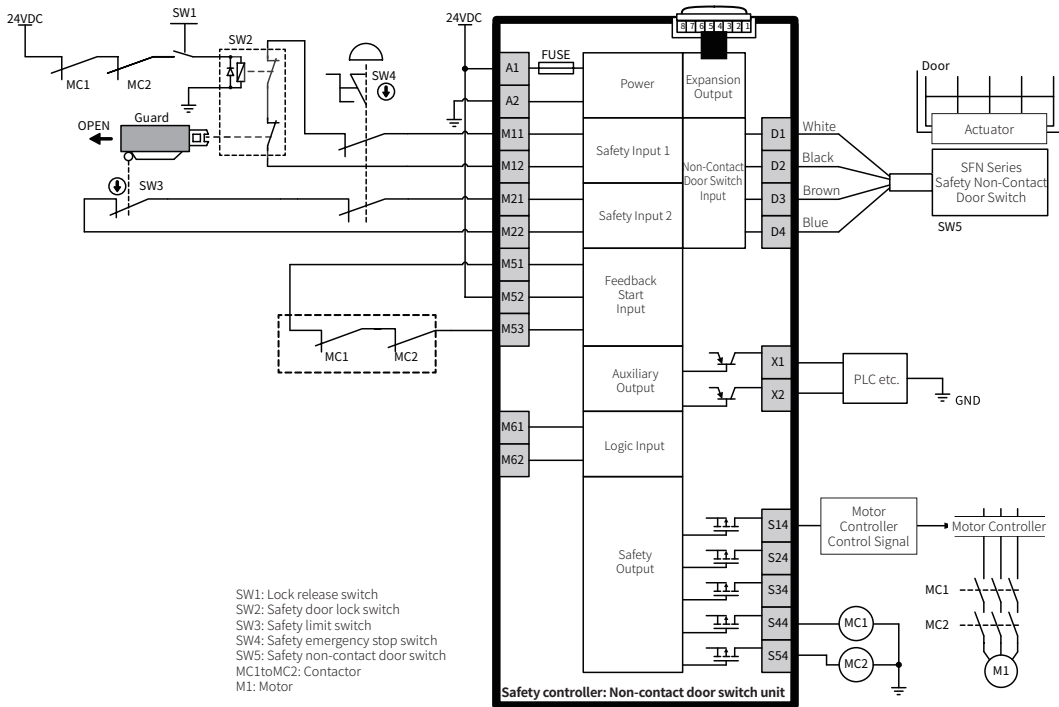

• Operation timing chart

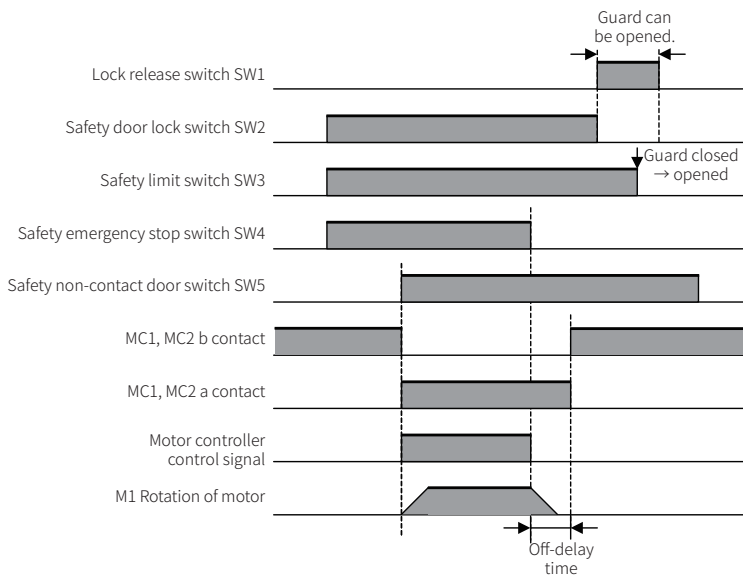

- For more information on detailed wiring for safety non-contact door switch (SFN Series), see the "Instruction manual for SFN."
- When you do not use the logic input (M61, M62), set the switch of the logic (AND) input (SW1, SW2) to OFF.
- Set the switches for off-delay time on the front and back of the non-contact switch unit to the same.

Connection Examples 4

Basic unit-Safety emergency stop switch, Non-contact door switch unit-Safety non-contact door switch

Connections	Start	PL/Safety category
Safety controller: Basic unit SFC Series Safety emergency stop button switch: SF2ER Series Push button switch (from Annex C of ISO 13849-1) Contactor of rated load (from Annex C of ISO 13849-1)	Manual	PLd/Cat.3 equivalent
Safety controller: Non-contact door switch unit SFC-N Series Push button switch (from Annex C of ISO 13849-1) Safety light curtain: SFL / SFLA Series Safety non-contact door switch: SFN Series Contactor of rated load (from Annex C of ISO 13849-1)	Auto	

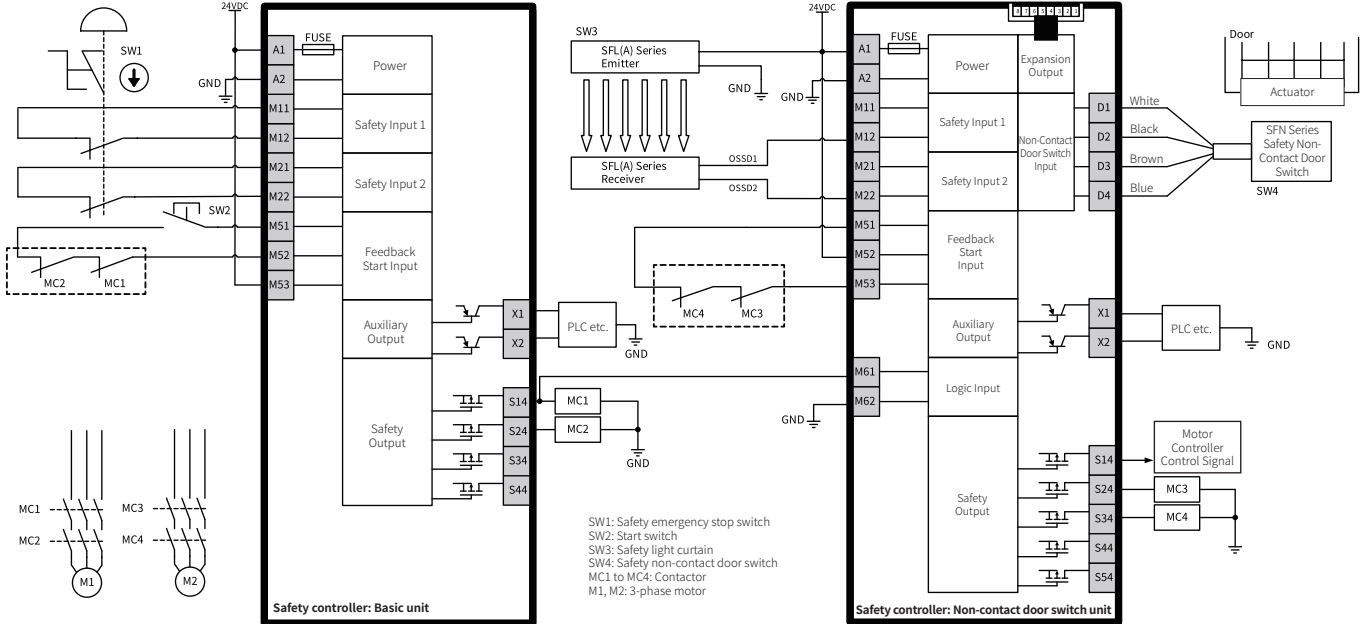

• Operation timing chart

Safety controller: Basic unit



Safety controller: Non-contact door switch unit

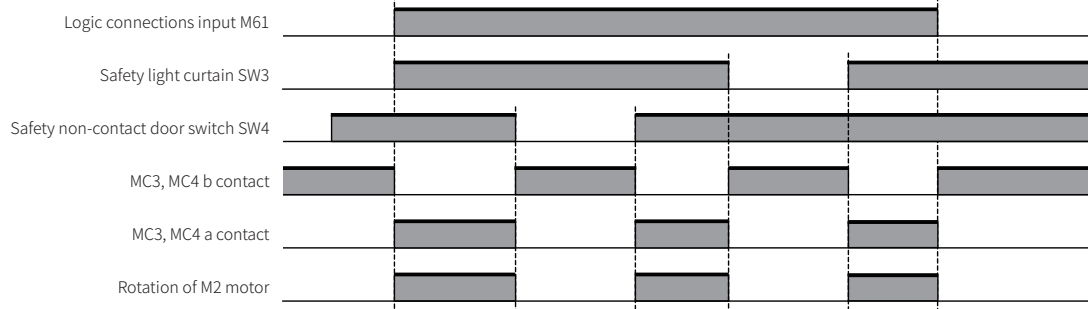

- For more information on detailed wiring for safety non-contact door switch (SFN Series), see the "Instruction manual for SFN."
- For more information on wiring and detailed settings for safety light curtain (SFL/SFLA Series), see the "SFL/SFLA user manual."
- The control output of the safety light curtain (SFL(A) series) is based on the PNP output.
- When you use the logic input (M61, M62), set the switch of the logic (AND) input (SW1, SW2) to ON.
- Set the switches for off-delay time on the front and back of the non-contact switch unit to the same.

Connection Examples 5

■ Relay unit-Safety emergency stop switch

Connections	Start	PL/Safety category
Safety controller: Relay unit SFC-R212 Safety emergency stop button switch: SF2ER Series Push button switch (from Annex C of ISO 13849-1) Contactor of rated load (from Annex C of ISO 13849-1)	Manual	PLe/Cat.4 equivalent

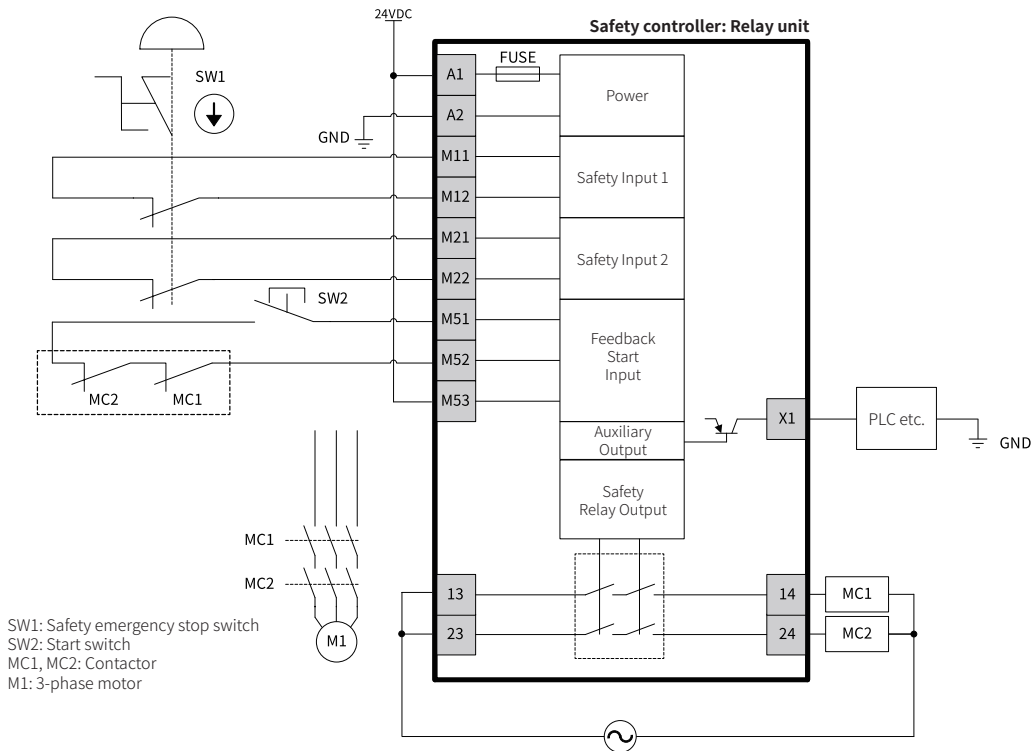

• Operation timing chart

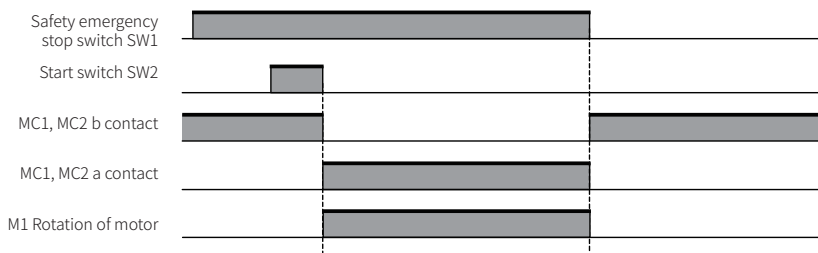

- When you do not use the logic input (M61, M62), set the switch of the logic (AND) input (SW1, SW2) to OFF.
- Set the switches for off-delay time on the front and back of the relay unit to the same.

Connection Examples 6

Relay unit-Safety light curtain

Connections	Start	PL/Safety category
Safety controller: Relay unit SFC-R412 Safety light curtain: SFL / SFLA Series Contactor of rated load (from Annex C of ISO 13849-1)	Auto	PLe/Cat.4 equivalent

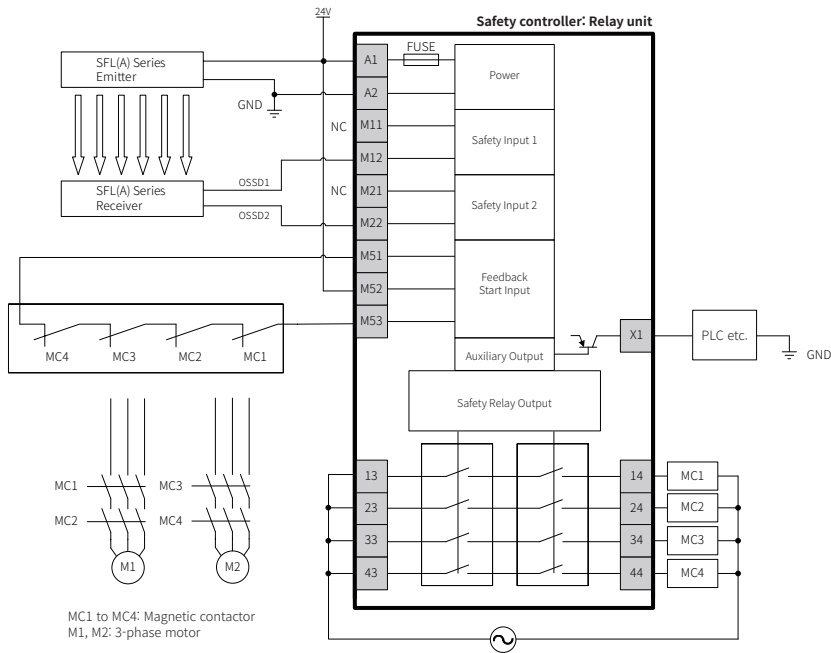

Operation timing chart

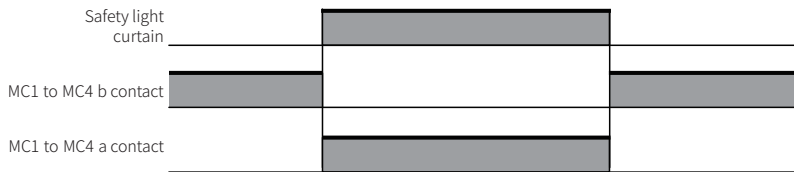

- For more information on wiring and detailed settings for safety light curtain (SFL/SFLA Series), see the "SFL/SFLA user manual."
- The control output of the safety light curtain (SFL(A) series) is based on the PNP output.

Connection Examples 7

Relay unit-Safety door lock switch

Connections	Start	PL/Safety category
Safety controller: Relay unit SFC-R212-R2□□ Safety door lock switch: SFDL Series Push button switch (from Annex C of ISO 13849-1) Contactor of rated load (from Annex C of ISO 13849-1)	Manual	PLe/Cat.4 equivalent

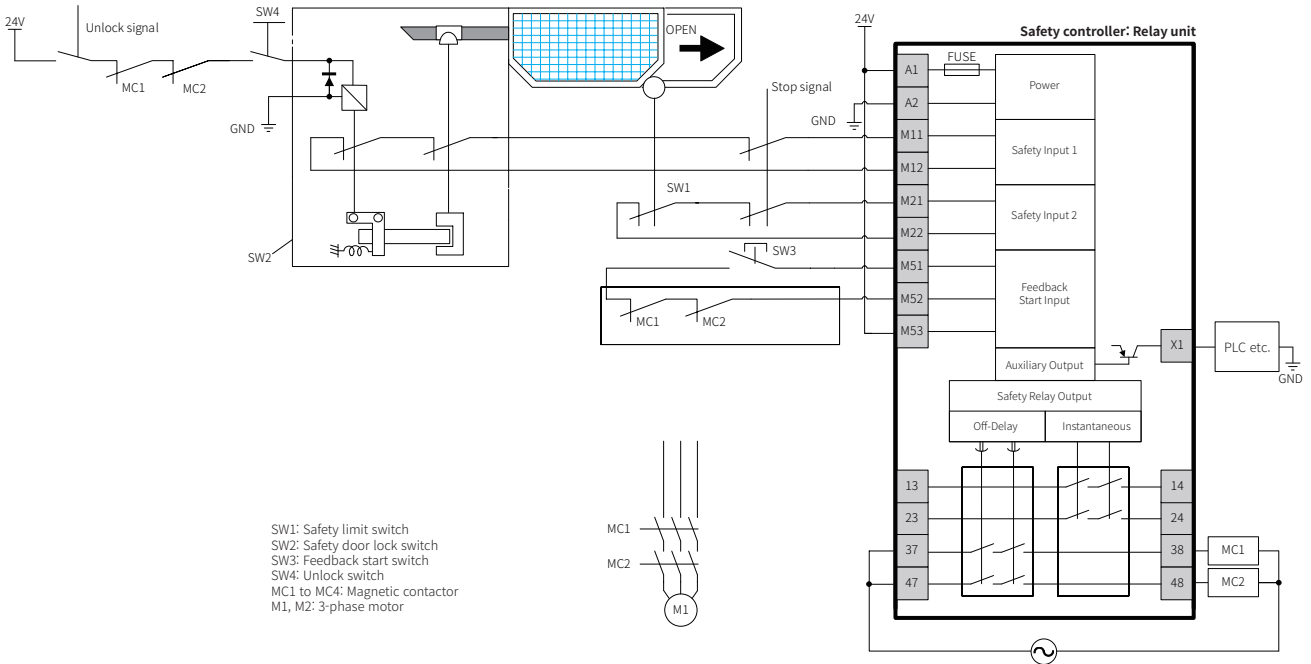

Operation timing chart

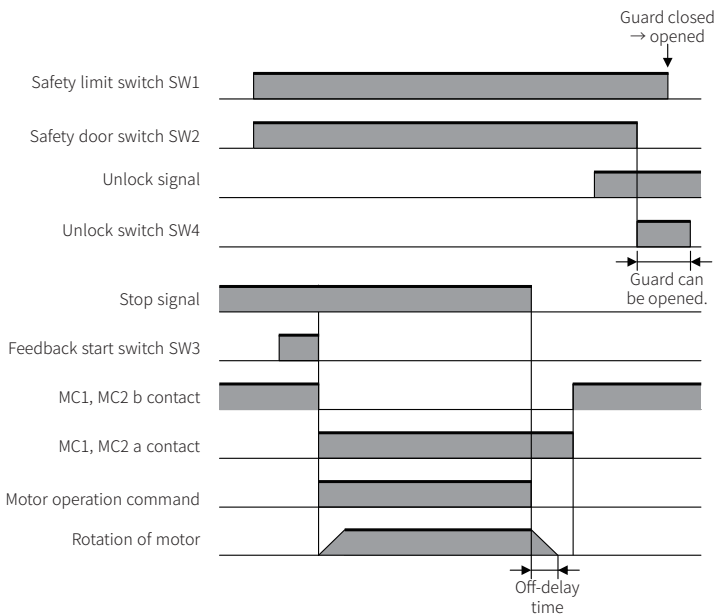

- Set the switches for off-delay time on the front and back of the relay unit to the same.